

100-17205,-D 28 Volts 240 Amps

PRODUCT SPECIFICATIONS

Part number	100-17205
System Voltage	24V
Rated Output	240A
Output @ 2000 rpm	90A
Ground	Negative
Mounting	J180 4"Hinge
Rotation	Bidirectional
Temperature limits:	
Low	-40°C / -40°F
High	110°C / 230°F
High	125°C / 257°F (with fresh air intake)
Speed limits:	
	8000 RPM continuous
	9000 RPM intermittent
Coating	Corrosion-Resistant E-Coated
Weight	38 Lbs / 17.4 Kg.
Regulator	Integral
Excitation	Self-Excite
Indicator Light	Yes
Remote Sense	Yes
Soft Start Delay (SSD)	Yes
Load Response Control (LRC)	Yes
Overvoltage Shut-Down (OSD)	Yes
Field Short Circuit Protection	Yes
Load Dump Protection	Yes

RECOMMENDED FOR:

- School & Shuttle Buses
- Utility Vehicles
- Marine & Mining
- Agricultural
- Construction & Industrial



100-17205



100-17205-D
with air intake cover

NOTE:

This DelStar 100-17205 alternator, meets the marine requirements for Ignition Protection on gas or diesel engines of ISO 8846, USCG, stated in Title 33 CFR 183.410, SAE J1171 and International CE Standards.

PERFORMANCE CURVES

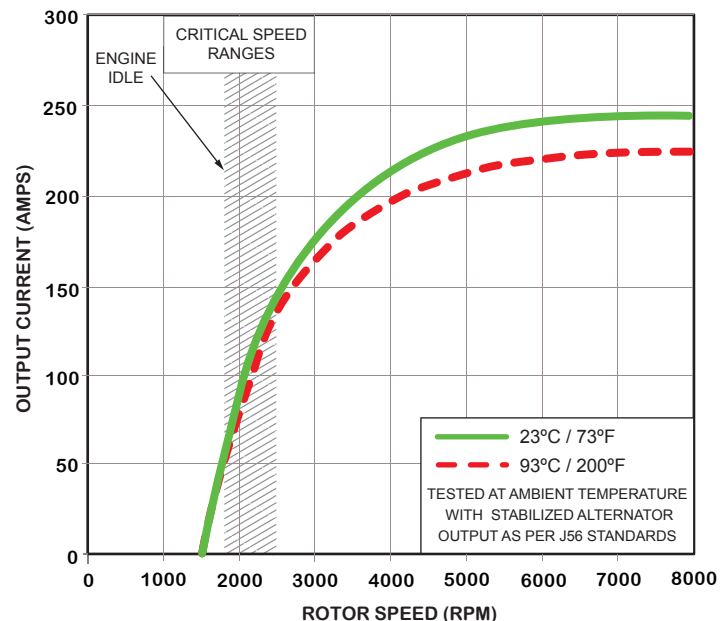

OUTLINE

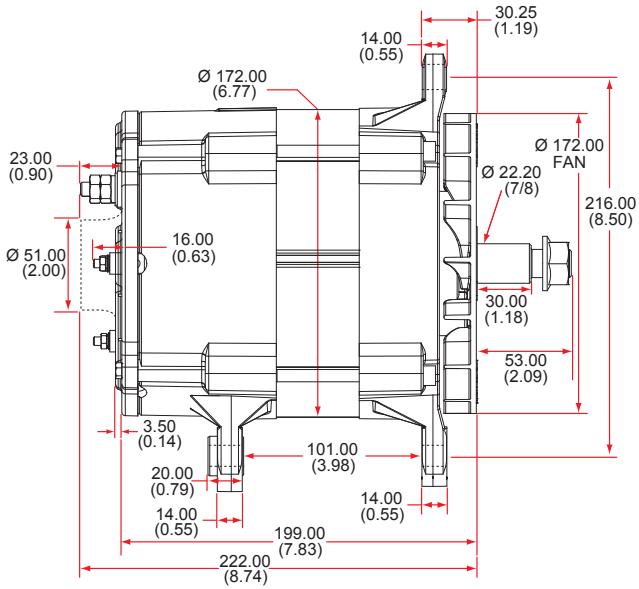

CONNECTIONS

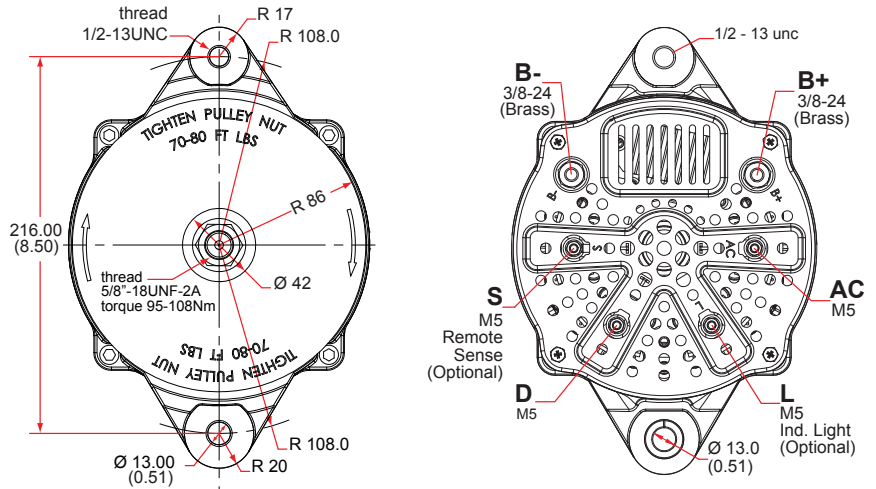

100-17205,-D
28 Volts 240 Amps

ELECTRICAL SCHEMATIC

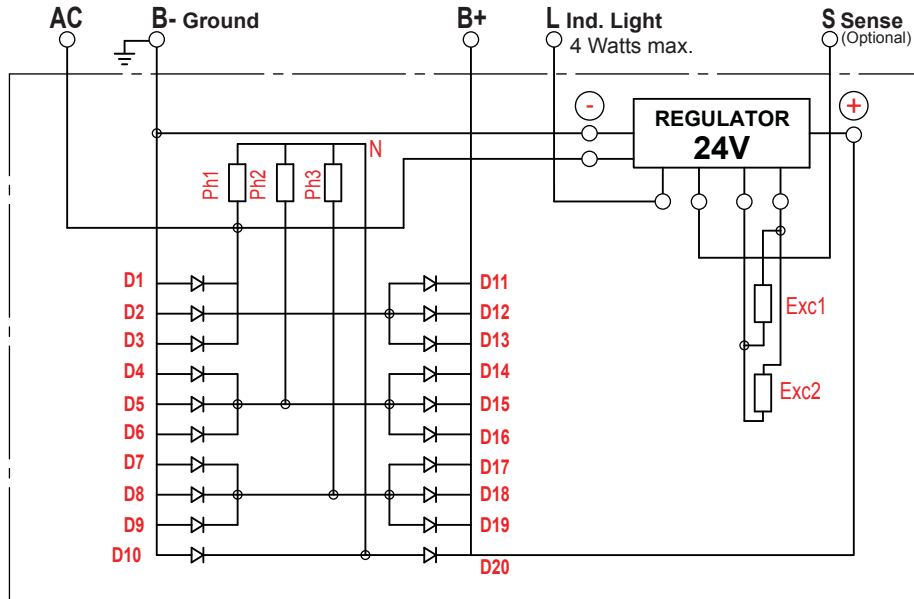

CANADA

Dixie Electric Ltd.
517 Basaltic Road
Concord, ON.
Canada L4K 4W8

Tel.: 905-879-0533 800-461-5799
Fax: 905-879-0532
E-Mail: sales@dixie-electric.com
Web Site: www.dixie-electric.com



U.S.A.

Dixie Electric Inc.
17100 Medina Rd, Suite 100
Minneapolis, MN.
U.S.A. 55447-1249

Tel.: 763-475-6629 800-478-0608
Fax: 763-475-6635 800-392-8719
E-Mail: mn.sales@dixie-electric.com
Web Site: www.dixie-electric.com