

100-18226 28 Volts 200 Amps

PRODUCT SPECIFICATIONS

Part number	100-18226
System Voltage	24V
Rated Output	200A
Output @ 2000 rpm	130A
Ground	Isolated
Mounting	T1-7" Left 60°
Rotation	Bidirectional
Temperature limits:	
Low	- 40°C / -40°F
High	110°C / 230°F
High	125°C / 257°F (with fresh air intake)
Speed limits:	
	7000 RPM continuous
	8000 RPM intermittent
Coating	Corrosion-Resistant E-Coated
Weight	51 Lbs / 23 Kg.
Regulator	Integral
Diode Trio (D+)	Indicator Light / Ignition
Remote Sense	M5 terminal
AC	M5 terminal

ACCESSORIES:

90° Elbow Pkg. (360° Rotatable) # 46900-1800

RECOMMENDED FOR:

- Coach & Transit Busses
- Marine
- Mining
- Construction, Industrial



w/ optional 90° elbow

NOTE:

This DelStar 100-18226 alternator, meets the marine requirements for Ignition Protection on gas or diesel engines of ISO 8846, USCG, stated in Title 33 CFR 183.410, SAE J1171 and International CE Standards.

PERFORMANCE CURVES

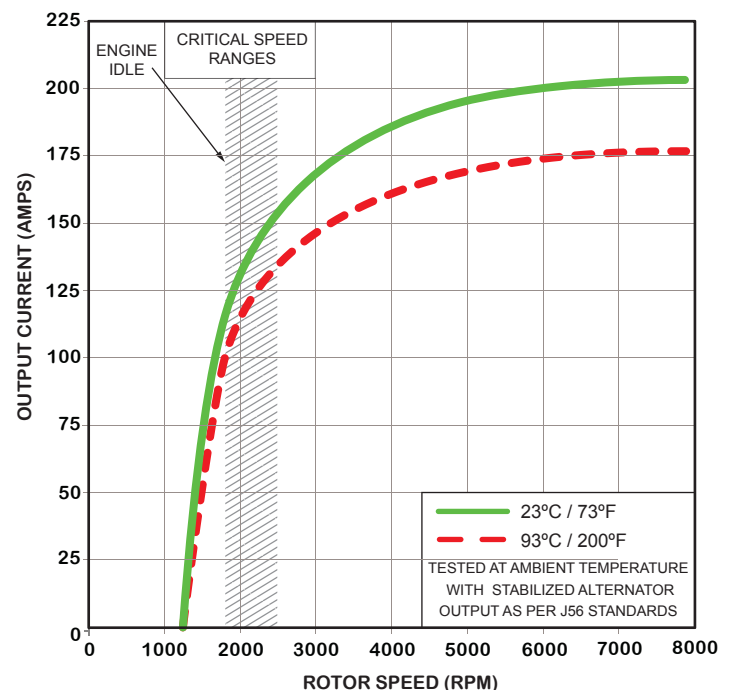

OUTLINE

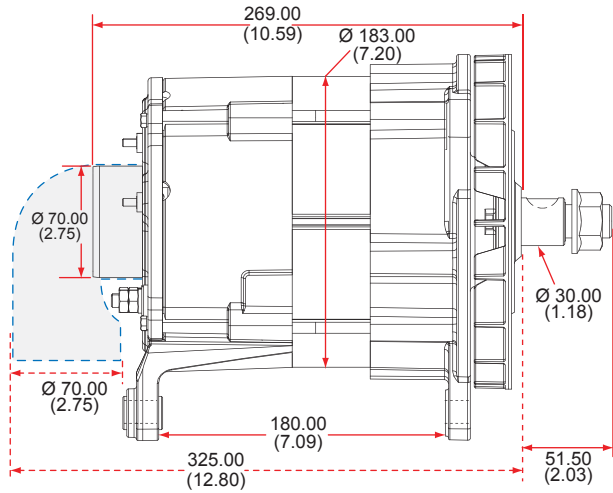

Dimensions are listed in mm over (in)

CONNECTIONS

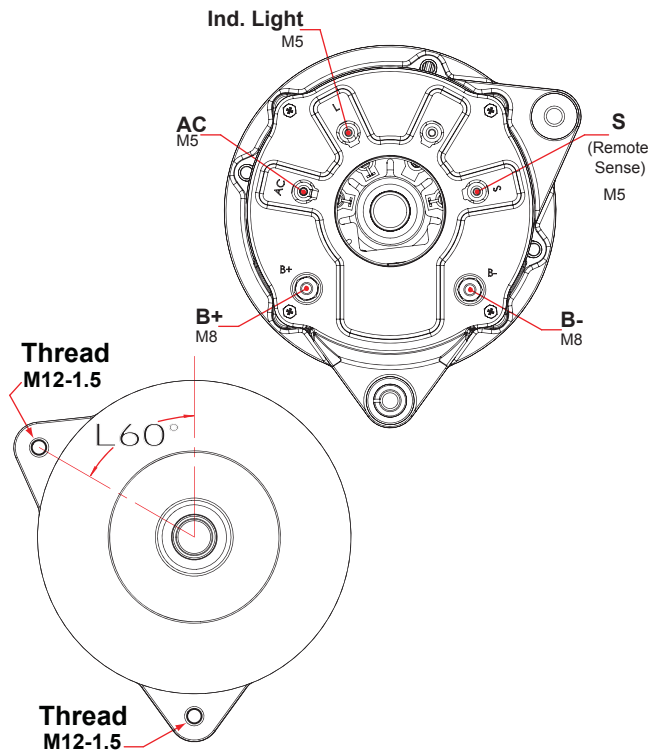

100-18226
28 Volts 200 Amps

ELECTRICAL SCHEMATIC

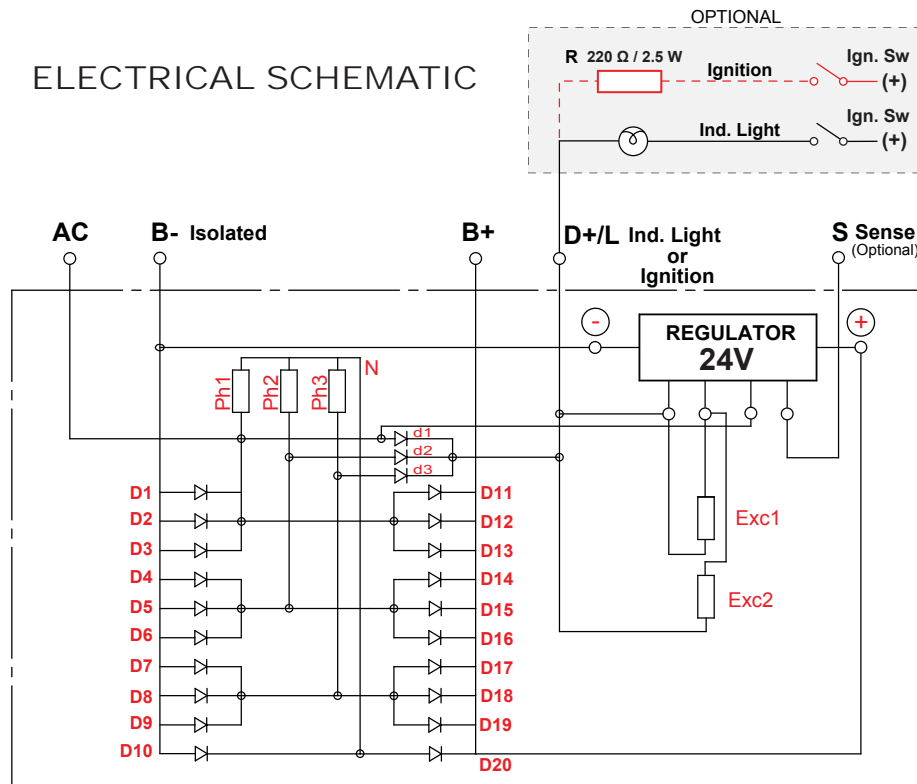

CANADA & EXPORT SALES

Dixie Electric Ltd.
517 Basaltic Road
Concord, ON.
Canada L4K 4W8

Tel.: 905-879-0533 800-461-5799
Fax: 905-879-0532
E-Mail: sales@dixie-electric.com
Web Site: www.dixie-electric.com



U.S.A. SALES

Dixie Electric Inc.
17100 Medina Rd, Suite 100
Minneapolis, MN.
U.S.A. 55447-1249

Tel.: 763-475-6629 800-478-0608
Fax: 763-475-6635 800-392-8719
E-Mail: mn.sales@dixie-electric.com
Web Site: www.dixie-electric.com